

LEKTRICO



ONE™
User and Installation
Manual

Documentation version: v1.0
August 2024

COPYRIGHT

©2023 by LEKTRI.CO®. All rights reserved. LEKTRI.CO® is a registered trademark of CIVITRONIC SRL.

ONE™ is a product designed and manufactured by LEKTRI.CO.

This document is copyright protected. Copying, reproduction or translation of this document or sections from this document, without prior written consent from LEKTRI.CO is strictly prohibited and is unlawful.

The information described in this document including any attachments is confidential and is intended only for the ONE™ users, therefore any disclosure or distribution (in any format) is strictly prohibited and is unlawful.

Any software applications or web portals that are needed to operate the ONE™ charger are subject to license agreements and can only be used in accordance with the terms and conditions of that specific agreement.

DISCLAIMER

The information presented in this document can be changed without prior notice and does not represent any commitment on the part of LEKTRI.CO.

The latest version of this document can be found at <https://lektri.co/downloads>

LEKTRI.CO is not liable to any person or business for any direct or indirect potential injuries, damages or losses caused by the improper installation or use of the ONE™ charger.

Installation of the ONE™ charger must always be performed by qualified personnel in electrical installations and accordance with the local electrical regulations.

Thank you for purchasing the LEKTRI.CO ONE™!

This manual provides a detailed explanation on how to install, configure and use the charger. For other languages, video instructions or support, please access this URL:

www.lektri.co/one

or scan this QR code

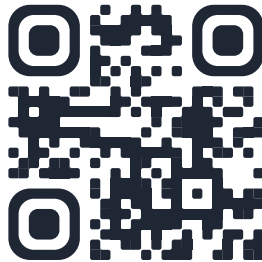

Contents

1. Safety instructions	5	5. Operating the charger	25
2. Meet your charger	6	5.1. Before first use	25
		5.2. Start the charging	25
3. Technical data	8	5.3. Stop the charging	25
3.1. General characteristics	8	5.4. Emergency stop	25
3.2. Electrical characteristics	8	5.5. Health and Safety	26
3.3. Connectivity	8	5.6. RFID	26
3.4. Mechanical characteristics	8		
3.5. Environmental characteristics	9	6. Charger configuration	27
3.6. LED status	9		
3.7. Transport and storage	11	7. Load balancing sensor installation and configuration	28
3.8. Applicable standards and certifications	11		
		8. Configure with LEKTRICO APP	31
4. Installation	13		
4.1. Necessary tools	13	9. Maintenance and support	33
4.2. Plan the installation	13	9.1. Maintenance	33
4.3. Before installing	14	9.2. Support	33
4.4. Installation steps	15	9.3. Warranty and support	34
4.5. Overall and mounting dimensions	22		
4.6. Troubleshooting	23	10. Notes	36

1. Safety instructions



Before starting to install and operate the charger, the user must always read this document very carefully, take into consideration all the warnings and follow all the instructions as described in this manual.

Failure to do so may result in electric shock which can be fatal or cause serious physical injuries.

ELECTRICAL WARNINGS

- The charger must always be installed by qualified personnel and in accordance with the electrical regulations applicable in your country.
- The charger is an electrical device that is always connected to mains power therefore touching uninsulated parts (e.g. interior PCB pins, connectors, uninsulated parts of the wires) will result in an electric shock.



DO NOT open the front cover when the charger is functioning, electric shock hazard.
DO NOT touch the connector pins.
DO NOT insert any tools inside the type 2 vehicle connector.

- If opening the front cover is necessary (e.g. during installation), always cut off the power supply of the charger from the dedicated circuit breaker.
- The charger must be operated only by adults.
- Adaptors, conversion adaptors and cord extension sets are not allowed to be used!
- Stop the supply in case the Red LED appears!



DO NOT touch any pins, electronic components and terminals on the printed circuit board (PCB) to avoid electrostatic discharges (ESD) that could damage the product.



Never install a product that is damaged.
Failure to do so may result in electric shock and/or material damages (electric vehicle included).

2. Meet your charger

This is a compact, connected and simple to use charger.

Congratulations on joining the electro-revolution!

Your new device is a single-phase charger with the capacity of charging your EV with up to 7,4 kW power.

Its smart features allow you to remotely control and configure the charger using the LEKTRI.CO mobile application.

To get started, after the installation, download the application and follow the instructions to connect it to your Wi-Fi network.

FEATURES

- Easy installation
- Compatible with any EV
- 5 meter charging cable with Type 2 connector
- Extend your ONE charger with our EM module for smart load and charge balancing. Your ONE charger is smart-home ready and can be integrated into your smart home ecosystem.
- Remote charge Start and Stop
- Load Balancing: Automated dynamic charge adjustment to avoid circuit breaker overload with EM add-on
- PV charge: Charge your EV with green energy with EM add-on
- Schedule charging
- Check our webpage for more information and systems supported.

SAFETY FEATURES

- Integrated residual current monitoring device (RCM, RDC-MD): 6mA DC and 20mA AC
- Overcurrent protection
- Overtemperature protection

Add your ONE™ charger to the LEKTRI.CO network to publicly share or earn money by selling charging sessions. Contact us for more information. (see **9.2 Support**)

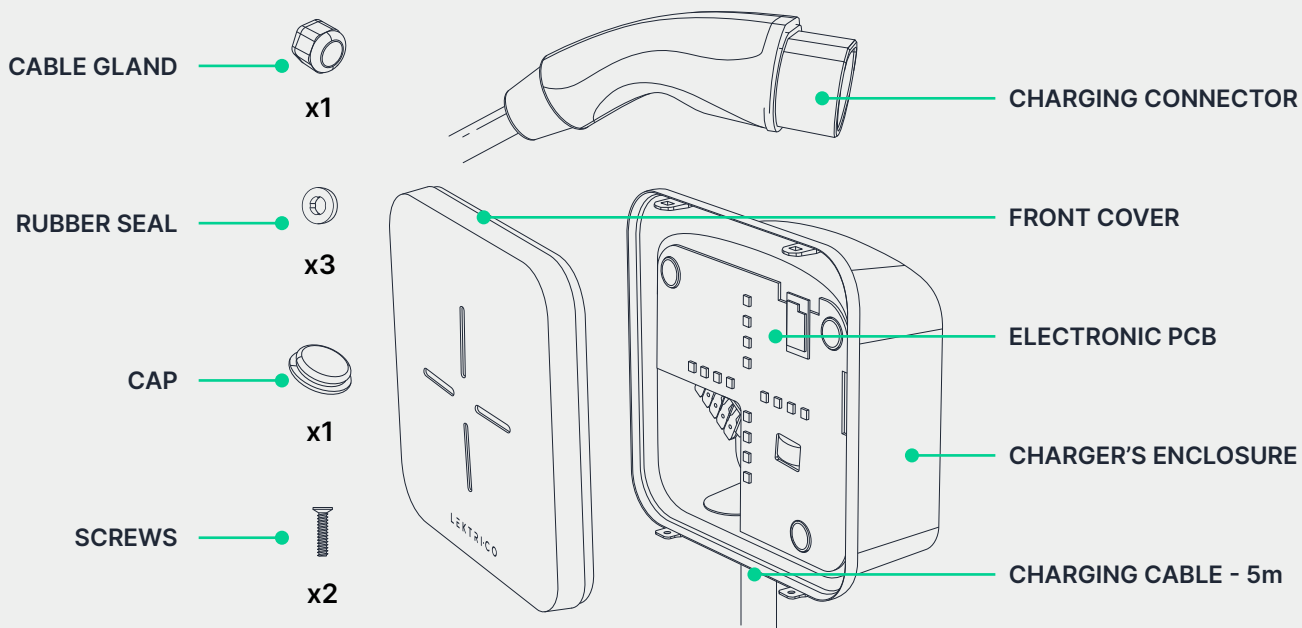

Fig. 1 - Main components of the ONE™ charger

The product label can be found on the backside of the charger.

The label provides useful information about the product:

- Manufacturer
- Serial number and a barcode
- Electrical characteristics
- Environmental characteristics
- Certifications



Extra label should be kept somewhere safe such as on the inside of the breaker board door.

The information on the label can be helpful for debugging and support.



Fig. 2 - The product label of the ONE™ charger

3. Technical data

3.1. GENERAL CHARACTERISTICS

- Charging mode: Mode 3
- Connector: IEC 62196 Type 2

3.2. ELECTRICAL CHARACTERISTICS

- Nominal voltage: 230VAC
- Nominal frequency: 50Hz
- Charging current: maximum 32A
- Programmable charging current: 6A ... 32A
- Charging power: 1.4kW ... 7.4kW
- Standby power consumption: 3.5W
- Charging cable: copper flexible cable, 3×6mm² +2×0.5mm²;
- Power inputs: L, N, PE

3.3. CONNECTIVITY

- Wi-Fi: IEEE 802.11 b/g/n - Frequency: 2.4GHz
- Bluetooth Low Energy

3.4. MECHANICAL CHARACTERISTICS

- Overall dimensions: 190mm x 190mm x 88mm
- Weight: 4kg (including the charging cable, connector and packaging).
- Protection class: IP55
- Shock protection: IK10
- Material: PC + ABS, flame-retardant (V0), recyclable, UV resistant.
- Power supply cable connectors: quick lever-action connector, mounted on PCB.
- Charging cable length: 5m
- Mounting solutions:
 - on a wall;
 - on a metal pillar (optional - can be purchased separately);

3.5. ENVIRONMENTAL CHARACTERISTICS

- Operating temperature range: -25°C ... +45°C
- Temperature range for storage and transport: -30°C and +60°C
- Relative humidity: maximum 96%, non-condensing

3.6. LED STATUS

ONE charger has one status LED on the front cover shaped like a cross which lights in different colours depending on the charger's status.



Fig. 3 - Charger LED status.

ONE CHARGER'S LED

Different charger statuses are represented by different LED colours as described below:



GREEN - Continuously lit: Available and unused (not connected to the electric vehicle).

GREEN - Fading in and out: Available and connected to Wi-Fi.



WHITE - Each segment is lit in a clockwise rotating pattern: Connected to the electric vehicle and charging.

WHITE - A single segment is pulsating: Charging is paused. The charging process may pause, if not enough power is available, according to the set load balancing mode.



PURPLE - Continuously lit: Connected to the electric vehicle and waiting for user / server to authorize the start of the charging process.

PURPLE - Fading in and out: Charger is in RFID tag learning mode. Tap a RFID tag on the charger (lower right area) to learn it. (see fig. 15 — page 26)



RED - Continuously lit: Error - general fault, charging not possible please see the Troubleshooting section or contact the manufacturer (for contact details see 9.2 Support section).

RED - Fading in and out: Charger is locked and cannot be used. This mode is useful for maintenance or testing purposes.



BLUE - Continuously lit: Connected to the electric vehicle and waiting for the car to start the charging process.



YELLOW - Continuously lit: The charger is performing a firmware update.

YELLOW - The two vertical segments lit: Device is performing factory reset.

3.7. TRANSPORT AND STORAGE

The charger must be transported with great care to avoid any impact forces that might damage the product.



DO NOT put heavy loads on top of the charger's package.

DO NOT step on the charger, charging cable or connector.

The charger must be stored in his package in a dust-free environment with a temperature between -30°C and +60°C and relative humidity of less than 96% non-condensing.

3.8. APPLICABLE STANDARDS AND CERTIFICATIONS

To ensure a high-quality product, ONE was designed and manufactured in accordance with the next standards:

- **IEC 61851-1** Electric vehicle conductive charging system - Part 1: General requirements.
- **IEC 61851-22** Electric vehicle conductive charging system - Part 22: AC electric vehicle charging station.
- **IEC 60068** Environmental testing.
- **IEC 60529** Degrees of protection provided by enclosures (IP Code).
- **Directive 2014/30/EU** regarding electromagnetic compatibility.
- **BS EN 55032** Electromagnetic compatibility of multimedia equipment. Emission Requirements.
- **IEC 61000-4-2** Electromagnetic compatibility (EMC) - Part 4-2: Testing and measurement techniques. Electrostatic discharge immunity test.
- **IEC 61000-4-4** Electromagnetic compatibility (EMC) - Part 4-4: Testing and measurement techniques. Electrical fast transient/burst immunity test.
- **IEC 61000-4-5** Electromagnetic compatibility (EMC) - Part 4-5: Testing and measurement techniques. Surge immunity test.

In addition to the above standards the ONE™ charger has the next certifications:

- **CE certification** – compliance with the health, safety and environmental protection standards for the European Economic Area (EEA).
- **Restriction of hazardous substances** – the design and the manufacturing process of this product is compliant with the RoHS 2 directive as per 2011/65/EU.
- **Waste certifications** – compliance with WEEE Directive 2012/19/EC (waste electrical and electronic equipment directive). This product must never be disposed ohwaf together with household waste.



4. Installation



Before starting to install and operate the charger, the user must always read this document very carefully, take into consideration all the warnings and follow all the instructions as described in this manual.

4.1. NECESSARY TOOLS

To properly install the charger, the following tools are required:



Drill machine



Drill bits



Step drill bit



Screwdrivers



Utility knife



Measuring tape



Marker/Pencil



Hammer



Cable cutting
plier



Cable stripping
plier

4.2. PLAN THE INSTALLATION

Before starting the installation, the following recommendations must be taken into consideration:

- Make sure the charger can be installed vertically, on a sturdy and fire-resistant wall or on the optional metal pillar that can be purchased separately;
- Make sure there is enough space to install the charger (see chapter **4.5 Overall and mounting dimensions** and **Fig. 14 Free area around the charger** when installed on a wall);
- Make sure that the IP55 protection class of the charger can be maintained (protected against dust and water splashes).

- Make sure that the necessary power supply cable (not included) from the junction box to the charger can be installed in accordance with the electrical regulations applicable in your country;
- Make sure that the electric vehicle can be parked for a long period in the vicinity of the charger in such a way that the included charging connector with its 5m of cable can be plugged into the electric vehicle's charging port;
- If an optional metal pillar is used, make sure that this is mounted in the highest point of the floor, in such a way that during rain the metal pillar base will not be sitting in a puddle of water.

4.3. BEFORE INSTALLING

Before installing the charger, the electrical installation for the power supply of the charger must be put in place. The electrical installation for the power supply of the charger must have the next characteristics:

- Single-phase power supply (L, N and PE)
- Maximum power supported: 7.4 kW;
- An appropriated electrical protection in the junction box; The electrical protection of the charger must contain a residual current device (RCD) with a tripping current $I_{\Delta n}=30\text{mA}$, type A, nominal current $I_n>40\text{A}$ and a manual reset, combined with a dedicated MCB (Miniature Circuit Breaker) with a nominal current $I_n=32\text{A}$ or 40A , tripping curve B or C and a rated breaking capacity of 6kA.



Check local electrical regulations regarding the necessity of installing an external emergency switch for the charger.

- A flexible (IEC 60228 class 5), flame-retardant and self-extinguishing cable with a wire cross-section of 6mm² or 10mm²;
- The cable must be properly secured and protected.



Due to the danger of electric shock, the electrical installation for the power supply of the charger must be always carried out by qualified personnel and in accordance with the electrical regulations applicable in your country.

Failure to do so may result in electric shock which can be fatal or cause serious physical injuries.



Because the installation of the charger differs from user to user, the required electrical equipment (e.g. breaker, wiring, installation accessories) is not unique and therefore is not delivered with the charger.

4.4. INSTALLATION STEPS

Depending on where the charger will be placed, there are two methods to install the charger:

1. Installation on a wall.
2. Installation on a metal pillar.

When deciding which installation method is best suited for you consider the recommendations described in section **4.2 Plan the installation**.

4.4.1. INSTALLATION ON A WALL

To install the charger on a wall follow the installation steps described below.

Installation steps:

1. Remove the charger from its packaging and make sure that all the components are included:
 - The front cover of the charger;
 - The main body of the charger (electronic PCB installed in the plastic enclosure);
 - Charging cable with type 2 connector (5m in length) already connected to the electronic PCB;
 - Quick installation guide with integrated drill template;
For more details see **Fig. 1 - Main components of the charger. (page 7)**
2. Inspect the charger for any damages. The main components of the charger described in step 1, must not reveal any cracks, defects or other imperfections. Also, the electrical insulation of the included charging cable must be intact. If defects are found, do not proceed with the installation process and immediately contact the manufacturer or the local supplier. For contact details please see section **9.2 Support**.



Never install a product that is damaged.

Failure to do so may result in electric shock and/or material damages (electric vehicle included).

3. Determine the best place for the charger to be installed, taking into consideration the recommendations described in section **4.2 Plan the installation (page 13-14)**.
4. Mark on the wall the position of the charger's 3 mounting points. For a quick and correct marking of the mounting points please use the provided drilling template. It is recommended to install the charger at 1,3m above the floor. **(Fig. 4 - page 16)**
5. Drill holes in the wall where the mounting points are marked. The diameter of the holes depends on what type of screw anchor are used. Always use anchor screws dedicated to your wall surface (e.g. brick/concrete, drywall, polystyrene insulation) and follow the recommendations of the anchor screw manufacturer.
Anchor screws and corresponding screws are not included. (Fig 6 - page 18)

6. Insert the screw anchor into the holes and make sure they are inserted all the way. If necessary, use a hammer and gently tap the anchor screws all the way into the holes.
7. Using a step drill bit, drill a 30mm diameter hole into one of the existing precut areas from the plastic enclosure. These easy to cut areas are used to insert the power supply cable into the main body of the charger.
There are 2 available easy to cut areas through which the power supply cable can be inserted into the charger. One area is on the **rear** of the enclosure and one area is on the **bottom left** side. (Fig. 5 - page 17)
8. If the rear cut-out area is used, insert the provided sealing cap in the cut-out hole. Insert the power supply cable through the sealing cap, to ensure water tightness. If the bottom left cut-out hole is used skip this step.
9. Fix the main body of the charger on the wall by inserting the screws with the provided **rubber sealing washer through the mounting points** and tighten them with a screwdriver by hand. (Fig. 6 - page 18)

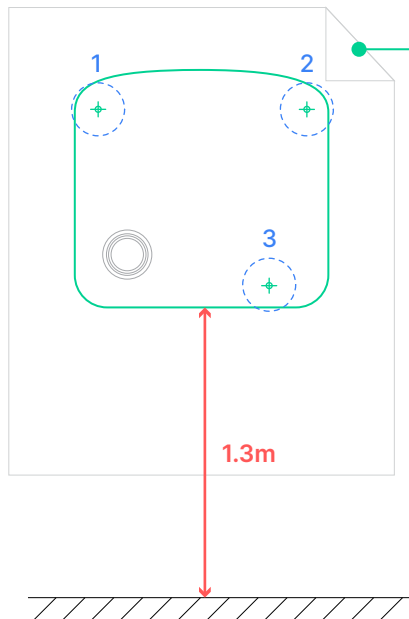

Quick User Guide information paper with drilling template. (provided in the box)

1, 2 and 3 - Marking and drilling spots.

The recommended distance between the charger and the floor is 1.3 meters.

Fig. 4 - Drilling template for the charger's mounting points

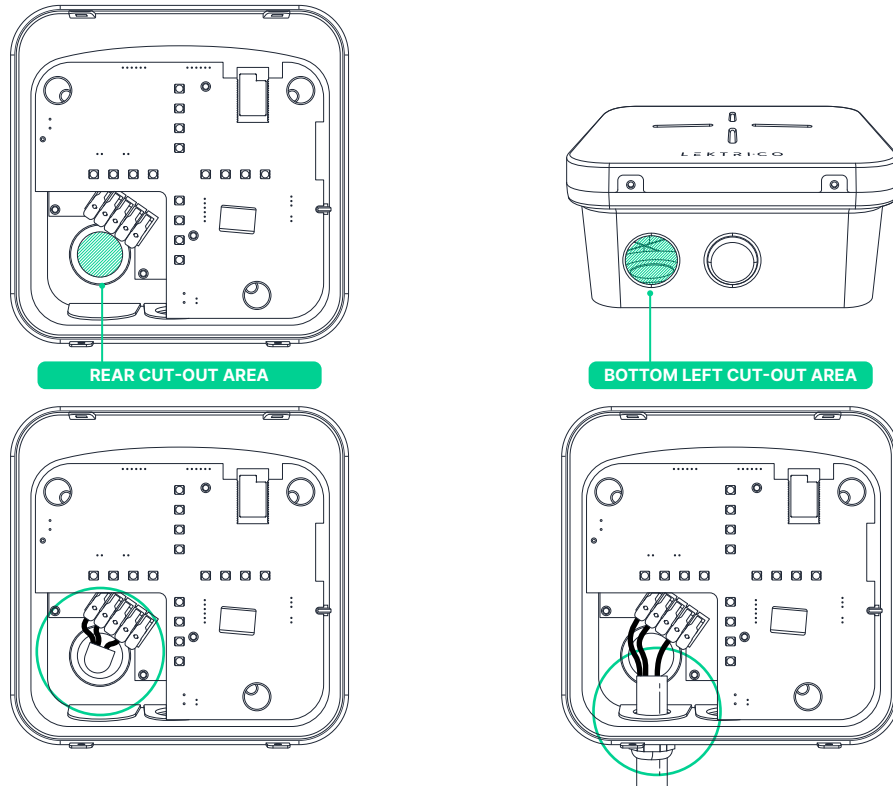

Fig. 5 - Cut out areas for the power supply cable



Overtightening the screws may cause the plastic enclosure of the charger to break.

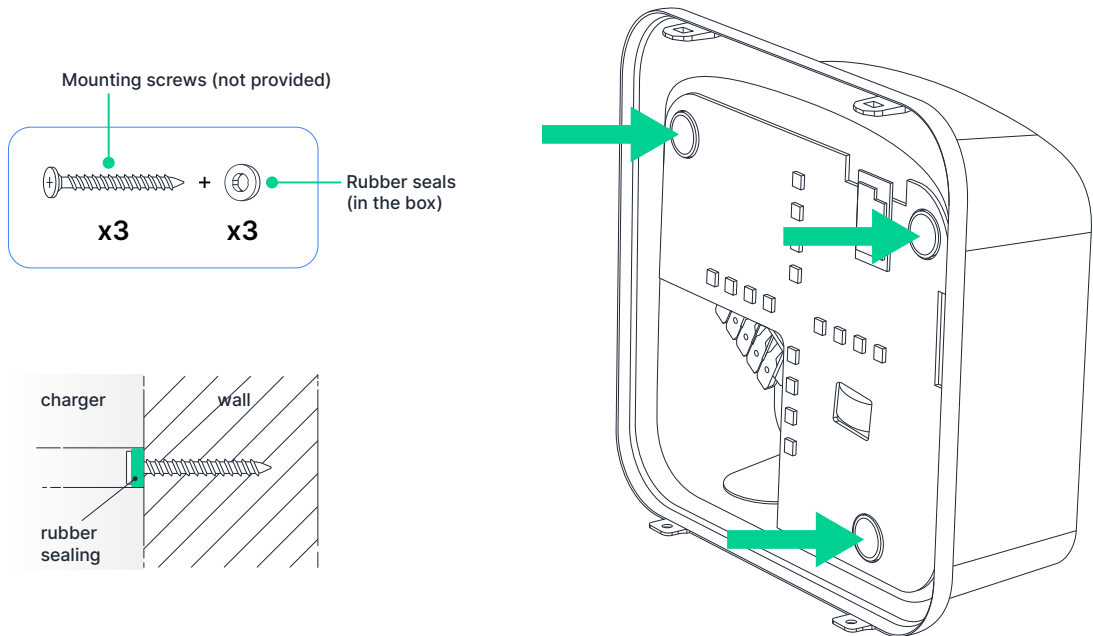

Fig. 6 - Mounting points of the charger

10. Install the cable gland in the bottom left cut-out area created at step 7. Fix the cable gland into position by tightening the lock nut.
11. Strip the main insulation of the power supply cable in such a way that 2 cm of insulation will be left inside the plastic enclosure of the charger.
12. Measure and cut the conductors of the power supply cable, in such a way that they can be easily and fully inserted into the cable connectors mounted on PCB.
13. Strip 12mm of insulation for each of the conductors of the power supply cable. **(Fig. 7 - page 19)**
14. Insert the power supply cable through the bottom cable gland. To maintain the protection class (IP55) of the charger, the supplied cable gland must be used.
15. Open the levers of the input connectors that are mounted on the left side of the PCB.

16. Insert the conductors of the power supply cable into the input connectors mounted on PCB and close each lever of the connectors. Be sure that the wires are fully inserted into the connectors, no stripped parts of the wires or strand wires must be visible (electrical protection against direct contact). Incorrect connection can result in improper contact which may cause a fire hazard. **(Fig. 8)**

IEC 60228 Copper Conductor Class 5

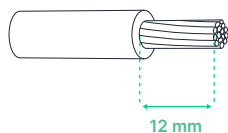

Fig. 7 - Insulation stripping length.



Always follow the wires succession as labelled on the PCB (printed circuit board).

An improper wire succession may lead to an electric shock which can be fatal or cause serious physical injuries or fire.

N 
L 
PE 

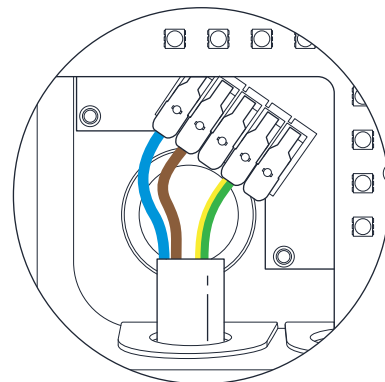

Fig. 8 - Wires succession of the power supply cable

17. Tighten the sealing nut of the cable gland, making sure that the cable gland seal is properly fit.
18. Verify that the rubber seal mounted on the inside border of the enclosure is fitted tight in the designated place. **(Fig. 9)**
If the front cover is installed over a rubber seal that is fitted improperly the IP55 protection class of the charger may be affected.
19. Install the front cover by gently pushing it into place, first in the bottom 2 fixing hooks and then in the 2 top fixing hooks. **(Fig. 10)**
20. Secure the front cover by tightening the 2 screws from the lower part. A Philips screwdriver is needed with a PH1 head. **(Fig. 11)**
21. Power up the ONE charger by arming the dedicated circuit breaker.
22. Check the front cover LED status. For more details about the front cover LED see chapter **3.6 LED status**.
23. Connect your charger to your Wi-Fi network to manage and configure it. To do this please follow the instructions on chapter **8. Configure with LEKTRI.CO App. (page 31)**

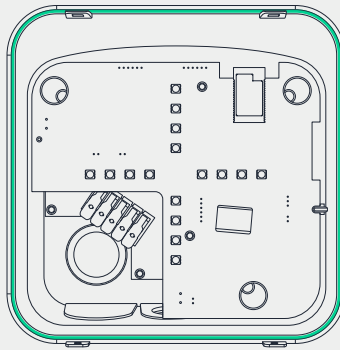

Fig. 9 - Rubber seal

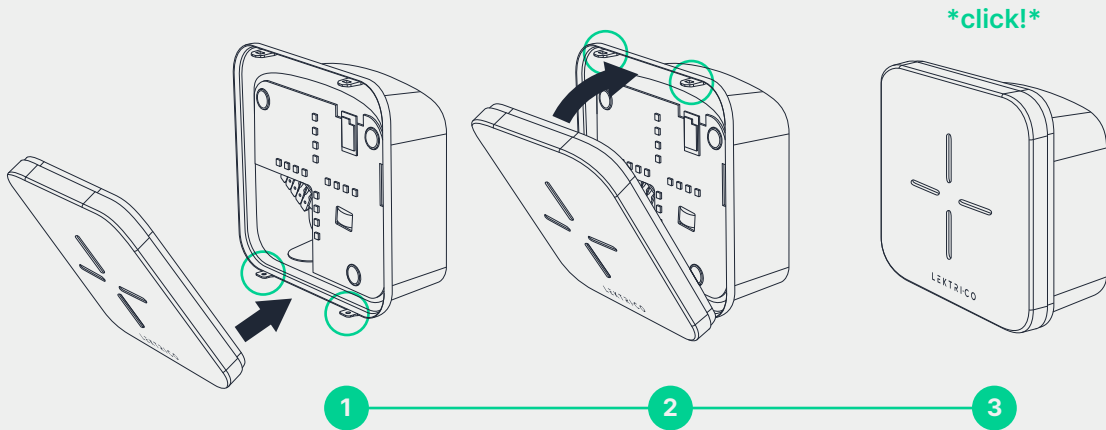

Fig. 10 - Install the front cover

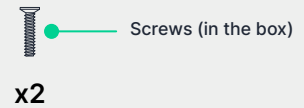
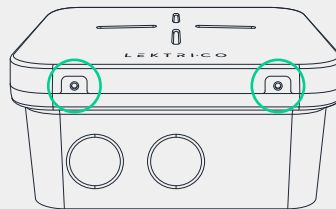
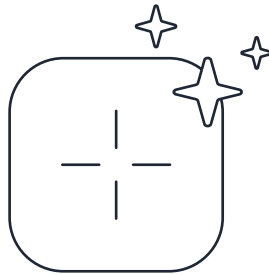

Fig. 11 - Front cover bottom securing screws

4.4.2. INSTALLATION ON A METAL PILLAR (OPTIONAL - CAN BE PURCHASED SEPARATELY)

To offer customers as much flexibility as possible in choosing the installation location for the charger, LEKTRI.CO has designed an optional metal pillar that can be purchased separately.

To install the a charger on the metal pillar please follow the installation steps described in the manual provided with the metal pillar.



**ENJOY YOUR NEW
CHARGER**

4.5. OVERALL AND MOUNTING DIMENSIONS

When the charger is installed on a wall make sure that there is 0,5m of free space on top and both sides of the charger, and 1,3m from the floor.

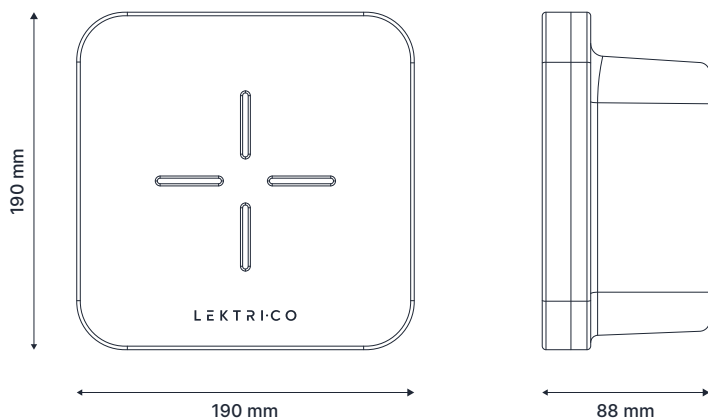

Fig. 12 - Overall dimensions of the charger

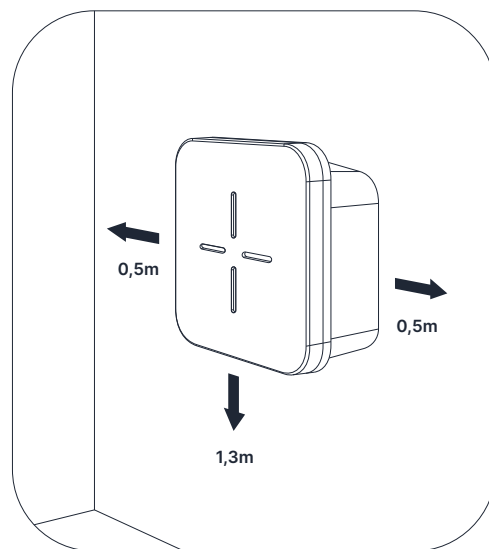

Fig. 13 - The free area around the charger when installed on a wall

4.6. TROUBLESHOOTING

If your charger is malfunctioning, please read the next pointers that could help you solve the malfunctioning problem.

THE CHARGER IS NOT POWERING UP

If the front LED is not lit, the power supply might be interrupted.

- Check that the dedicated circuit breaker from the junction box is on.

ELECONECAL VEHICLE CHARGING DOES NOT START

There could be multiple reasons for charging not to start:

- Check that the connector plug is inserted properly into the electric vehicle charging port
 - Try to reconnect the connector plug;
- Check that the pins of the connector plug are not damaged or full of debris (e.g. dust, dirt);



Always cut off the power supply of the charger from the dedicated MCB before cleaning the pins of the connector plug.

- Check that the remote server authorized the start of the charging process;
- Check that the electric vehicle is not fully charged and that there is no error on board;

CHARGING POWER IS LOWER THAN EXPECTED

There could be multiple reasons why the charging power may be reduced and lower than the maximum (installation) set current:

- **Charging power may be limited by EV:** the EV might only be capable of slower charging or might reduce the power at the end of a charging cycle.
- **Dynamic current limiting:** when using the power management add-on or when controlled by API or a smart home, the charger will reduce the power according to the requested current. Check connected device or restart the charger if necessary.
- **Charger may be overheating:** the power is reduced to decrease the temperature. Might happen if the charger is installed in a sunny place, thus exceeding the operating temperature.

THE CONNECTOR PLUG CANNOT BE DISCONNECTED FROM THE ELECONEC VEHICLE

Make sure that the charging process is finished by the electric vehicle. Check the user guide of the electric vehicle for details about how to stop the charging process.

GENERAL ERROR – FRONT LED IS LIT SOLID RED

If the front LED is lit solid red, a general error occurred. Disconnect the electrical car and try restarting the charger. A more detailed description of the error is available through the charger's user interface. If the problem persists please contact the manufacturer or your local supplier. For contact details see **9.2 Support**.

CANNOT ACCESS THE CHARGER IN THE LEKTRI.CO APP

- Make sure you are connected to the same Wi-Fi network as the charger.
- Make sure that your router is capable of multicast DNS (mDNS) and DNS Service Discovery (DNS-SD).
- Restart the router and charger.

RESET TO FACTORY DEFAULTS

If the charger continues to malfunction try to reset the device to factory defaults. This option is available in the LEKTRI.CO Mobile App. If the charger is not accessible via the app, the charger's factory reset switch can be used.

Switch off the charging station by switching off the corresponding circuit breaker.

Remove the front cover to reveal the top part of the PCB where the reset to factory defaults switch can be found (see Fig. 14).

Toggle the switch, by sliding it from the original position to the opposite position.

Place the cover back and power the device by connecting it's circuit breaker.

The charger should now show a vertical yellow line, meaning that it is reverting to the factory default settings, after which the device will show solid green LEDs and is ready to be configured and used.

Please contact LEKTRI.CO or your local supplier for additional information about reset to factory defaults procedure. For contact details see **9.2 Support**.

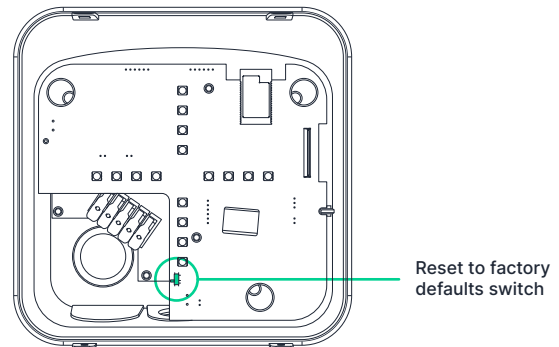

Fig. 14 - Reset to factory defaults switch

5. Operating the charger

5.1. BEFORE FIRST USE

1. Make sure the charger was properly installed and it is safe to use. For proper installation follow the instructions described in chapter **4. Installation**.
2. Using the LEKTRI.CO mobile app, connect to your charger and configure it according to the installation. For more details see chapters **6 and 7**.
3. The front cover LED is green, fading in and out, meaning that the charger is available and unused (not connected to the electric vehicle). For more details about front cover LED different states see section **3.6 LED status (page 10)**

5.2. START THE CHARGING

To start the charging process, connect the charging cable to the electric vehicle and make sure is locked. The charger is starting to communicate with the car through the type 2 connector. The front cover LED will continuously light blue. After the car starts the charging process the front cover LED will start to light white and each segment is lit in a continuously rotating pattern.

5.3. STOP THE CHARGING

When the charging process is finished the front cover LED will light continuously blue.

To stop the charging process before the car is fully charged, you can either stop it from your car's interface or by using the LEKTRI.CO app. After the charging process is finished or stopped, disconnect the type 2 connector from the car and wrap the charging cable around the main body of the charger in such a way that the connector and the charging cable do not touch the ground.

5.4. EMERGENCY STOP

In case of a fatal error or if smoke or fire is visible an emergency stop is required. To perform an emergency stop, power down the charger by disconnecting the dedicated circuit breaker from the main junction box.

In case of smoke or fire immediately alert emergency services and if possible, try to extinguish the fire only with dedicated utensils for extinguishing electrical installations up to 1000V like powder or CO2 fire extinguishers or use sand.

5.5. HEALTH AND SAFETY

The health and safety requirements related to electrical devices must be followed during the use of the charger.



Unauthorized interventions are strictly forbidden, only qualified personnel can carry out interventions.

Failure to do so may result in electric shock which can be fatal or cause serious physical injuries.

5.5. RFID

The RFID (if installed) can be used for authentication of a charging session using a RFID/NFC tag.

Use the app to teach a new tag.

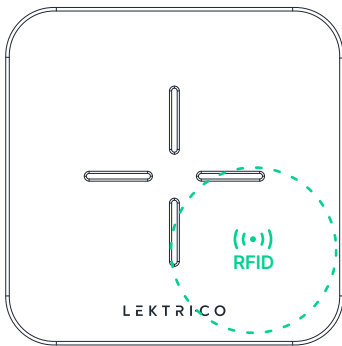

Fig. 15 - RFID tag area

6. Charger configuration

To configure the charger use the dedicated LEKTRI.CO app.

The following parameters can be configured:

1. Alias

Give your charger an alias name (nickname) to easily identify it in the dashboard. Tip: even use Emojis!

2. Load Balancing Mode

Menu to set and manage the Power Management device and Load Balancing Mode.

3. Plug and Charge

Enable this to directly start charging when plugged into a car.

Disable to require authentication via App, API, Cloud or OCPP before starting a charging process.

4. Access Point (direct) WiFi password

The WiFi access point (hotspot) of the charger is not secured by default. Set a password if you would like to restrict access to the charger, when it is not connected to another WiFi network.

5. LED brightness

The brightness of the LEDs may be reduced with this setting.

6. Max current

The maximum current your charger should charge with.



This value should only be set by an authorized electrician, according to the electrical installation.

7. Firmware update

The device automatically checks for updates, but may also be updated manually here.

8. Factory reset

Resets the charger to its factory setting and wipes all user data.

9. OCPP server

Option to connect to an OCPP server for remote management.

10. Restart device

7. Load balancing sensor installation and configuration

Before starting the installation, please read this manual thoroughly. Failure to follow recommended procedures may malfunction, endanger life, or violate the law. The manufacturer is not responsible for any loss or damage in the event of incorrect installation or operation of the device

Use

The complementary load balancing module allows you to manage and balance the load between your electrical system and EV charger so that power consumption is kept within the limit of the main circuit breaker.

Load balancing modes:

- **Disabled**

This mode disables any load balancing but continues to report meter values.

- **Power**

This is the normal mode of operation, ensuring that the circuit breaker's set limit is not exceeded. Any connected charger will adjust its charging power to meet the set limit.

- **Hybrid**

Hybrid mode allows you to use the solar panels and redirect the excess energy to charge your car. Instead of injecting the surplus into the grid, this mode will adjust the charging current so that all the surplus energy is used for charging. This mode will allow the minimum charging current to continue if no excess is available.

- **Green (ECO)**

Green (ECO) mode will only charge your car with green energy: charging will only start and use surplus solar energy if enough surplus solar energy is available. If the solar power output drops below the minimum charging current, charging will stop until solar power is available again.

Installation

The magnetic core current clamp will be installed on the live cable after the utility meter so that all electricity consumption/production goes through it.

At the bottom of the magnetic core current clamp, you will see an arrow showing you the direction of current/voltage flow to follow when installing. This should point from the grid to your home.

Ensure the power clamp is on the same phase/circuit as the charger you want to connect.

Follow this diagram to connect your device.

1-Phase Energy Management Module Installation Diagram

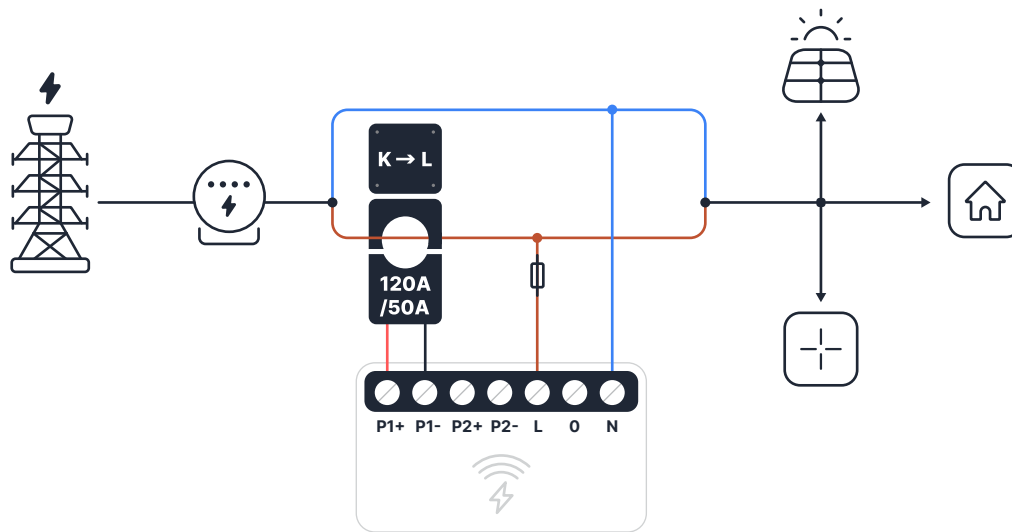

EM specifications

- Power supply - 110-230V $\pm 10\%$ 50/60Hz AC
- Maximum measurement per channel - 50A or 120A (depending on the current clamp model) / 230V
- Maximum relay load - 2A/230V
- Working temperature - 40°C 40°C
- Radio signal power - 1mW
- Radio protocol - WiFi 802.11 b/g/n
- Frequency: 2412-2472 MHz; (max. 2483.5 MHz)
- Range (depending on local construction) - up to 50m outdoors, up to 30m indoors
- Dimensions (HxWxL) - 39×36×17 mm
- Power consumption - < 1 W



Danger of electric shock! The device will be permanently installed by qualified electricians following local regulations.

Do not connect the current transformer clamp to the line before wiring it to the EM. Even if only the current transformer is connected, there could be high voltage on its connecting cables.

Even when the device is turned off, there may be voltage at its terminals. Every change to the terminal connection must be made after ensuring that all local power is switched off/disconnected.

Do not connect the device to appliances that exceed the indicated maximum load! Connect the device only as indicated in these instructions. Any other method could cause damage and injury.

Use the device only with electrical networks and appliances that comply with all applicable regulations. A short circuit in the grid or any machine connected can damage the device.



The device may be connected to and control electrical circuits and appliances only if they comply with the respective safety standards and regulations.

The information presented in this document is subject to change without prior notice and does not represent any commitment from LEKTRI.CO.

LEKTRI.CO is not liable to any person or company for any direct or indirect injury, damage, or loss caused by improper installation or device use.

Declaration of conformity

Allterco Robotics EOOD declares that the Shelly EM radio equipment complies with Directive 2014/53/EU, 2014/35/EU, 2014/30/UE, 2011/65/EU. The full text of the EU declaration of conformity is available at the following internet address: <https://shelly.cloud/knowledge-base/devices/shelly-em/>

Manufacturer: Allterco Robotics EOOD

Address: Bulgaria, Sofia, 1407, 103 Cherni brah Blvd.

Tel: +359 2 988 7435

Email: support@shelly.cloud

Web: <http://www.shelly.cloud>.

©2021 LEKTRI.CO®. All rights reserved. LEKTRI.CO® is a registered trademark of SC CIVITRONIC SRL.

All rights to the She® and Shelly® trademarks and other intellectual property rights associated with this device belong to Allterco Robotics EOOD.



8. Configure with LEKTRI.CO APP

To configure and control your Lektrico chargers, we recommend using the LEKTRI.CO App, available for Android and iOS. Find it in Google Play or App Store, or by scanning the QR code below.

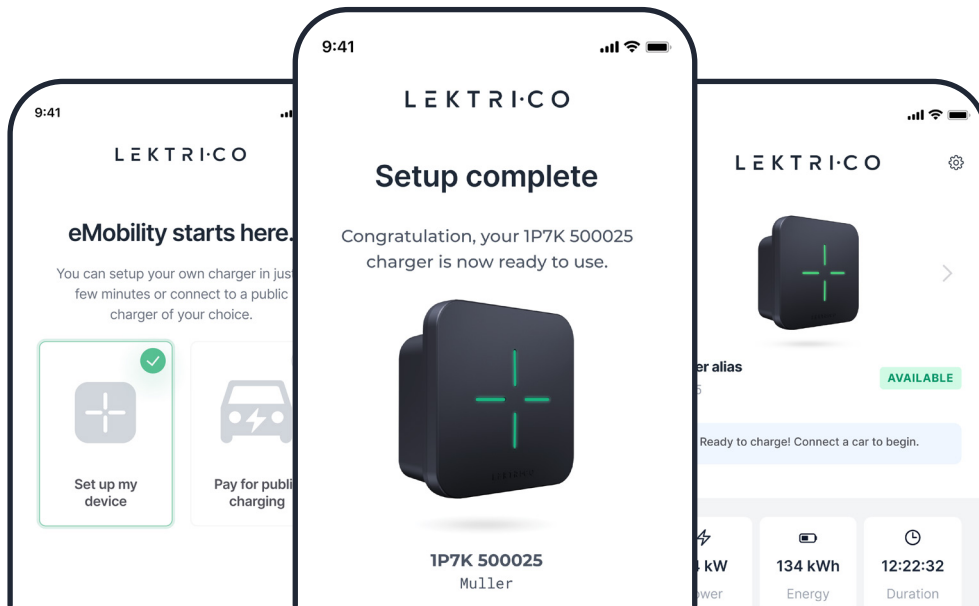
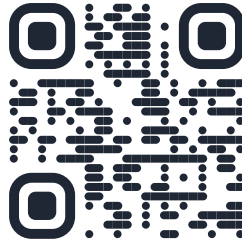

Fig. 16 - Configure charger with LEKTRI.CO app

The app will first help you to connect the device to your WiFi network. Later on, with the LEKTRI.CO App you will be able to access and control your charger locally or remotely.

When the device setup is completed, you will see your charger in the dashboard. Now you can control the charge, charging power and access the chargers settings.

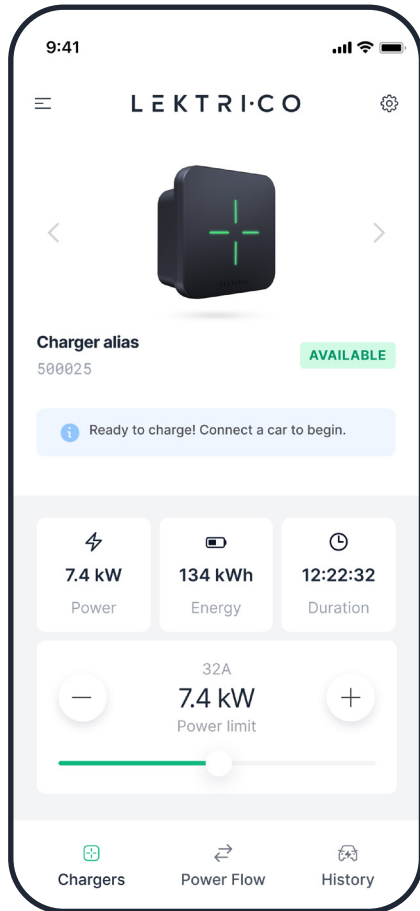

Fig. 17 - LEKTRI.CO app dashboard

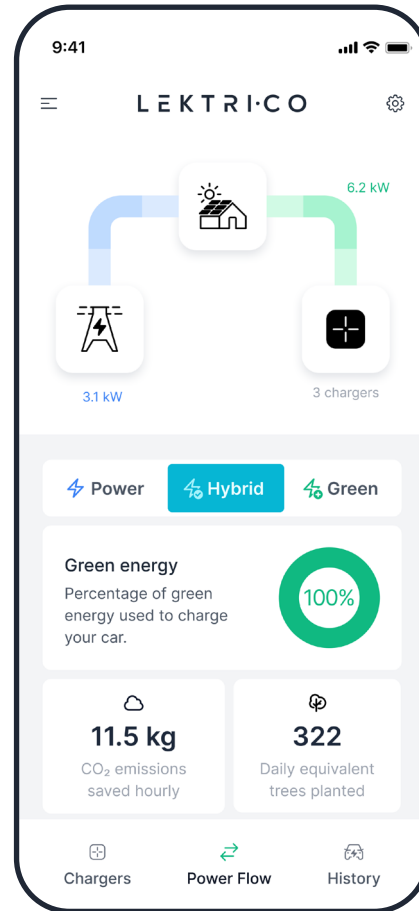

Fig. 18 - LEKTRI.CO app charging

9. Maintenance and support

9.1. MAINTENANCE

Although the charger was designed to function without maintenance, it is recommended to periodically check the charger's condition.



Always turn off the power supply of the charger before checking the charger's condition.

Charger's condition checklist:

- Check the plastic enclosure for damages (cracks, defects or other imperfections);
- Check that the electrical insulation of the included charging cable is intact;
- Check that the housing of the type 2 connector is intact;
- Check that the type 2 connector's pins are not bent, oxidized and free of any debris (e.g. dust, dirt);
- Check that there is no water trapped inside the connector pin's rubber protection cover;



If defects are found, stop using the charger immediately and contact the manufacturer or the local supplier.



To avoid damages to the charging cable and type 2 connector, when not in use, wrap the charging cable around the charger.

Whenever it is necessary use a dry cloth to remove any dust, dirt or water droplets from the charger's plastic enclosure. Do not use any cleaning solvents or water to clean the charger.

9.2. SUPPORT

For any additional information, questions or service please contact LEKTRI.CO or your local supplier.

LEKTRI·CO

 support@lektri.co

 +40 31 630 0747

 Rozelor street, no. 7, Timișoara,
TM 300317, România

9.3. WARRANTY & SUPPORT

Civitronic SRL provides an electronic vehicle charging solution for home and business users by the **LEKTRI.CO** brand. It includes an intelligent charging hardware device and an online service for control of the charging functions of the device that is accessible locally on a network and remotely through the Internet via a website and a mobile application.

This statement of **limited warranty** applies to the intelligent charging hardware device and related accessories ("Equipment") provided by **LEKTRI.CO**.

In the event of defects, the buyer must inform Civitronic SRL immediately in order to exercise the right to have the defect rectified.

OTHER RIGHTS YOU MAY HAVE

ALTHOUGH THIS WARRANTY GIVES YOU SPECIFIC LEGAL RIGHTS, YOU MAY HAVE OTHER RIGHTS IN YOUR JURISDICTION. THIS STATEMENT OF LIMITED WARRANTY IS SUBJECT TO APPLICABLE LAWS THAT APPLY TO YOU AND THE EQUIPMENT. PLEASE REVIEW THE LAWS IN YOUR JURISDICTION TO UNDERSTAND YOUR RIGHTS FULLY.

Who is Covered by LEKTRI.CO's Limited Warranty

This statement of limited warranty covers users of the Equipment — either individuals who purchased Equipment from LEKTRI.CO or one of its authorized resellers or distributors, or who received Equipment as a gift from such a purchaser.

Limited Warranty Coverage

For a period of 24 MONTHS from the date of your purchase, LEKTRI.CO warrants that the Equipment shall be free from defects in material and workmanship under normal use and service.

Warranty Benefits

If, during the applicable warranty period, the user returns defective Equipment to LEKTRI.CO, accompanied by LEKTRI.CO's return authorization form, and LEKTRI.CO's examination of such Equipment discloses to LEKTRI.CO's satisfaction that such products are defective and such defects are not caused by abuse, misuse (used for purposes other than to charge an EV), neglect, alteration, improper installation, repair, improper testing, accident, natural disaster, usage outside specified ambient conditions, usage contrary to any instructions issued by LEKTRI.CO, acts of vandalism, normal wear and tear, overvoltage due to lightning strike or grid imperfections or instability, unauthorized opening, demounting or moving, after-hours travel and labor, or the Equipment was not maintained and / or stored according to our instructions and has been left without power for an extended period of time, LEKTRI.CO shall, at its sole option, either repair, replace, or refund to the user the lesser of the standard retail purchase price of such Equipment or the purchase price you paid as shown on your proof of purchase. No Equipment may be returned to LEKTRI.CO without our returned authorization form.

Obtaining Limited Warranty Service, product return procedure

For warranty service, shipping instructions and a return authorization form please contact us at LEKTRI.CO, by email support@lektri.co or by phone **+40316300747**.

Please ship the Equipment to LEKTRI.CO with proof of purchase, which is required in order to obtain repairs, replacement, or refunds under this statement of limited warranty. The user will need to pay for shipment of the Equipment to LEKTRI.CO, LEKTRI.CO will pay for the shipment of any repaired or replacement Equipment.

Sole and Exclusive Warranty

THE FOREGOING WARRANTY CONSTITUTES LEKTRI.CO'S EXCLUSIVE LIABILITY, AND THE SOLE AND EXCLUSIVE REMEDY OF THE USER, FOR ANY BREACH OF ANY WARRANTY OR OTHER NONCONFORMITY OF THE EQUIPMENT COVERED BY THIS STATEMENT OF LIMITED WARRANTY. THIS WARRANTY IS EXCLUSIVE, AND IN LIEU OF ALL OTHER WARRANTIES. NO EMPLOYEE OF LEKTRI.CO OR ANY OTHER PARTY IS AUTHORIZED TO MAKE ANY WARRANTY IN ADDITION TO THE WARRANTY IN THIS STATEMENT OF LIMITED WARRANTY.

Disclaimer of Warranties

EXCEPT AS WARRANTED ABOVE, TO THE MAXIMUM EXTENT PERMITTED BY APPLICABLE LAW, LEKTRI.CO PROVIDES THE EQUIPMENT "AS IS", LEKTRI.CO MAKES NO OTHER WARRANTIES, EXPRESS, IMPLIED, OR STATUTORY, AND LEKTRI.CO HEREBY DISCLAIMS ALL WARRANTIES, REPRESENTATIONS, OR CONDITIONS, EXPRESS OR IMPLIED, INCLUDING WITHOUT LIMITATION ANY WARRANTIES OF MERCHANTABILITY, FITNESS FOR A PARTICULAR PURPOSE, OR NON-INFRINGEMENT. SOME JURISDICTIONS DO NOT ALLOW EXCLUSIONS OF AN IMPLIED WARRANTY, SO THIS DISCLAIMER **MAY NOT APPLY TO YOU, AND YOU MAY HAVE OTHER LEGAL RIGHTS THAT VARY BY JURISDICTION.**

Limitations of Liability

UNDER NO CIRCUMSTANCES WHATSOEVER SHALL LEKTRI.CO OR ITS SUPPLIERS BE LIABLE FOR INDIRECT, SPECIAL, INCIDENTAL, OR CONSEQUENTIAL DAMAGES, EVEN IF LEKTRI.CO OR ONE OF ITS SUPPLIERS HAS BEEN ADVISED OF THE POSSIBILITY OR LIKELIHOOD OF SUCH DAMAGES. EXCEPT AS COVERED BY THIS STATEMENT OF LIMITED WARRANTY, LEKTRI.CO SHALL NOT BE LIABLE FOR COSTS ASSOCIATED WITH THE REPLACEMENT OR REPAIR OF PRODUCT, INCLUDING, BUT NOT LIMITED TO, LABOR, INSTALLATION, OR OTHER COSTS INCURRED BY THE USER AND, IN PARTICULAR, ANY COSTS RELATING TO THE REMOVAL OR REPLACEMENT OF ANY PRODUCT. IN NO EVENT SHALL LEKTRI.CO'S LIABILITY FOR ANY AND ALL CLAIMS, LOSSES, OR DAMAGES ARISING OUT OF OR RELATING TO, IN WHOLE OR IN PART, THIS STATEMENT OF WARRANTY OR THE EQUIPMENT, WHETHER UNDER CONTRACT, TORT, NEGLIGENCE, STATUTE, OR OTHERWISE, EXCEED THE PURCHASE PRICE PAID BY THE USER FOR THE EQUIPMENT. THE FOREGOING LIMITATIONS AND EXCLUSIONS OF DAMAGES SHALL APPLY TO THE MAXIMUM EXTENT PERMITTED BY APPLICABLE LAW. IN SOME JURISDICTIONS, SOME EXCLUSIONS OR LIMITATIONS MAY NOT APPLY TO YOU.

Exclusions from Warranty Coverage

The warranty in this statement of limited warranty does not cover damage caused by abuse, misuse (used for purposes other than to charge an EV), neglect, alteration, improper installation, repair, improper testing, accident, natural disaster, usage outside specified ambient conditions, usage contrary to any instructions issued by LEKTRI.CO, acts of vandalism, normal wear and tear, overvoltage due to lightning strike or grid imperfections or instability, unauthorized opening, demounting or moving, after-hours travel and labor.

Also, chargers must be maintained and / or stored according to our instructions and may not be left without power for an extended period of time. The warranty in this statement of limited warranty does not cover the consumable parts of the charger.

Any improper installation, improper use, accidents or normal wear are not covered by this warranty.

10. Notes

LEKTRICO